

SILICON POINT CONTACT MIXER DIODES

ASI Point Contact Mixer Diodes are designed for applications from UHF through 26 GHz.

They feature high burnout resistance, low noise figure and are hermetically sealed. They are available in DO-7, DO-22, DO-23 and DO-37 package styles which make them suitable for use in Coaxial, Waveguide and Stripline applications.

These mixer diodes are categorized by noise figure at the designated test frequencies from UHF to 26GHz.

BAND	FREQUENCY (GHz)
UHF	Up to 1
L	1 to 2
S	2 to 4
C	4 to 8
X	8 to 12.4
K μ	12.4 to 18.0
K	18.0 to 26.5

These diodes are available as matched pairs and are supplied in either forward pairs (M) or forward/reverse pairs (MR). The matching criteria for these mixer diodes is:

1. Conversion Loss— $\Delta L_c = 0.3\text{dB}$ maximum
2. I_f Impedance— $\Delta Z_{IF} = 25\ \text{OHMS}$ maximum

The overall noise figure is expressed by the following relationship:

$$NF_o = L_c (NR_o + NF_{IF} - 1)$$

NF_o = overall receiver noise figure

NR_o = output noise temperature ratio of the mixer diode

NF_{IF} = noise figure of the I.F. amplifier (1.5dB)

L_c = conversion loss of the mixer diode

NOISE FIGURE TEST SCHEMATIC

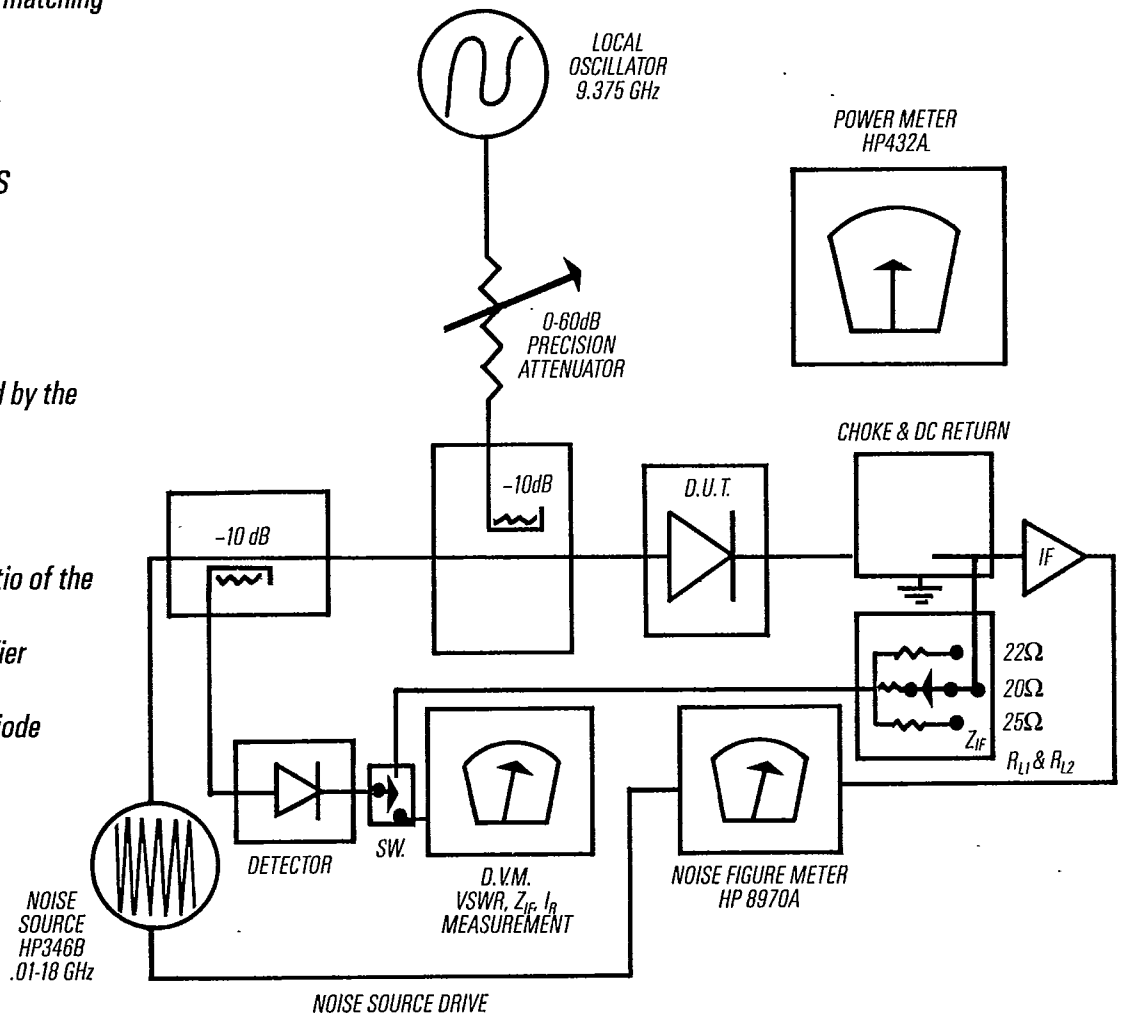

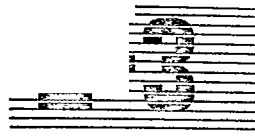

TYPICAL PERFORMANCE

NOISE FIGURE VS FREQUENCY

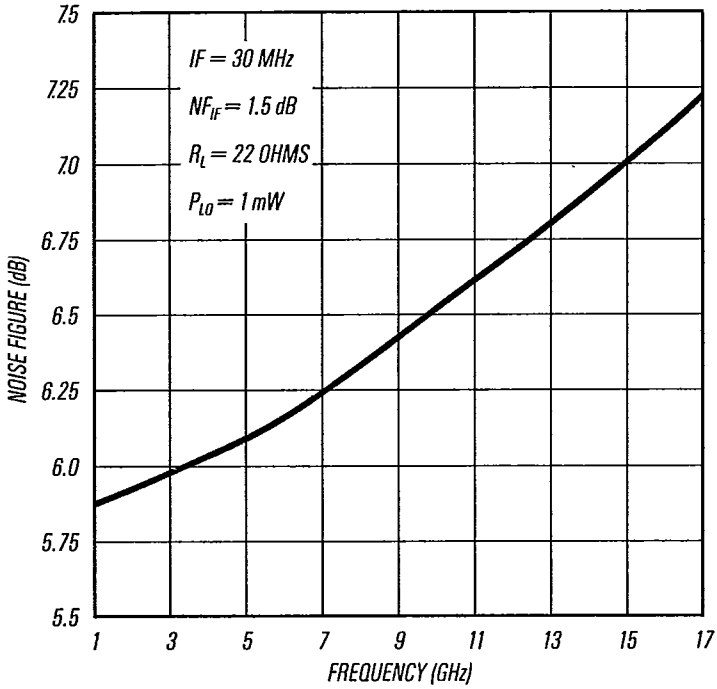

IF IMPEDANCE VS LO POWER

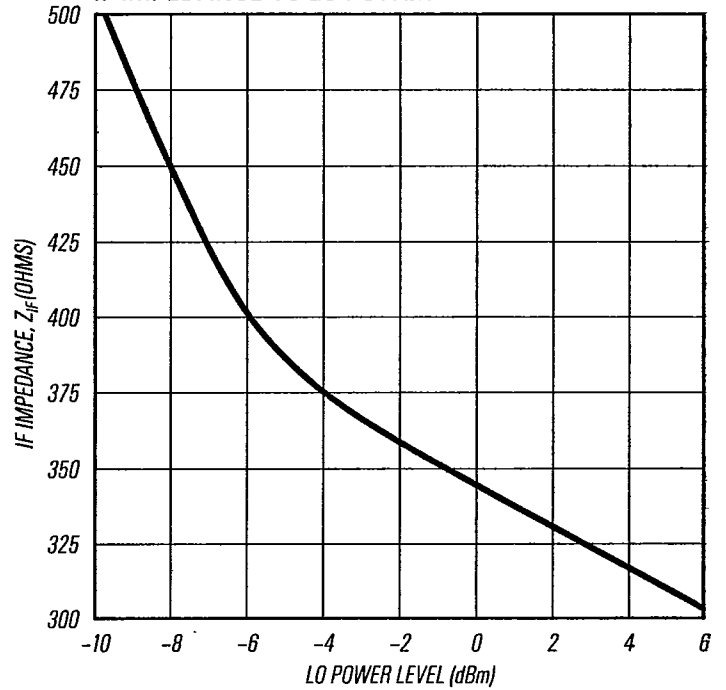

NOISE FIGURE VS LO POWER

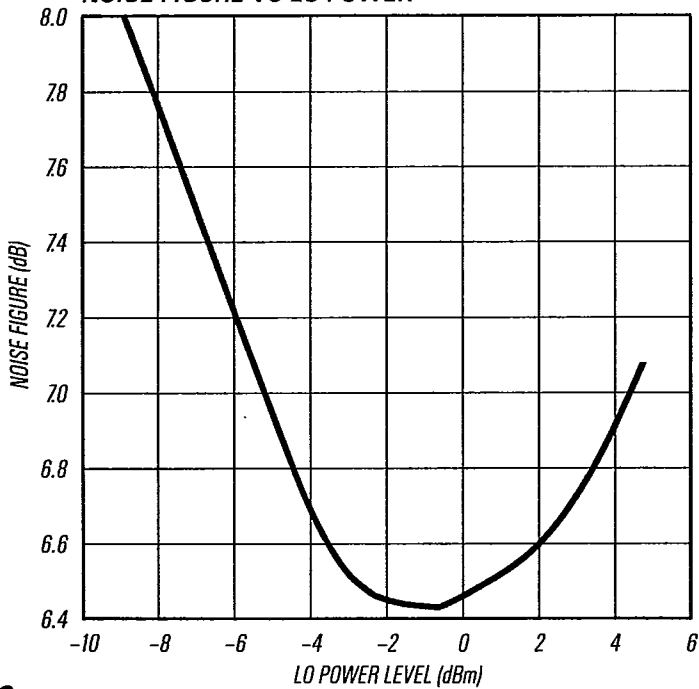

VSWR VS LOCAL OSCILLATOR POWER

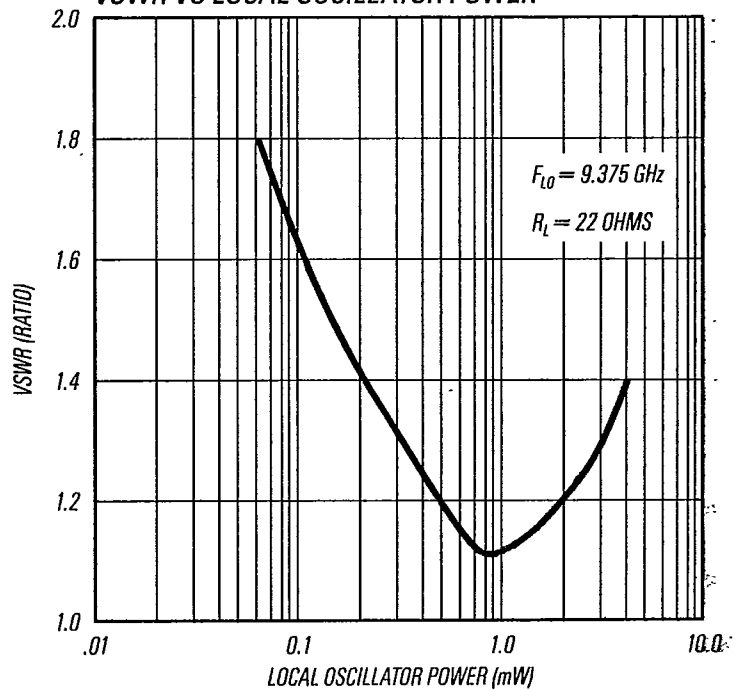

POINT CONTACT MIXER DIODES

L, S, C-BAND

FREQUENCY BAND	TYPE NUMBER					NOISE	
	POLARITY			MATCHED PAIRS		NOISE RATIO MAX.	NOISE ¹ FIGURE N_f , dB MAX.
	FORWARD	REVERSE	REVERSIBLE	TWO FORWARD POLARITY DIODES	ONE FORWARD ONE REVERSE POLARITY DIODES		
L	1N25	1N25R		1N25M	1N25MR	2.0	12.6
L	1N25A	1N25AR		1N25AM	1N25AMR	2.0	10.3
L	1N25B	1N25BR		1N25BM	1N25BMR	1.5	8.3
S	1N21C	1N21CR		1N21CM	1N21CMR	1.5	8.3
S	1N4294	1N4294R		1N4294M	1N4294MR		
S			1N416C	1N416CM	1N416CMR	1.5	8.3
S			1N831	1N831M		1.5	8.3
S			1N3655	1N3655M		1.5	8.3
S	1N21D	1N21DR		1N21DM	1N21DMR	1.3	7.3
S			1N416D	1N416DM	1N416DMR	1.3	7.3
S	1N21E	1N21ER		1N21EM	1N21EMR		7.0
S			1N416E	1N416EM	1N416EMR		7.0
S			1N21WE	1N21WEM	1N21WEMR		7.0
S			1N831A	1N831AM			7.0
S			1N3655A	1N3655AM	1N3655AMR	1.5	7.0
S	1N21F	1N21FR		1N21FM	1N21FMR		6.0
S			1N416F	1N416FM	1N416FMR		6.0
S			1N3655B	1N3655BM	1N3655BMR	1.5	6.0
S			1N831B	1N831BM			6.5
S			1N831C	1N831CM			6.0
S	1N21G	1N21GR		1N21GM	1N21GMR		5.5
S			1N416G	1N416GM	1N416GMR		5.5
S			1N21WG	1N21WGM	1N21WGMR		5.5
S	1N21H	1N21HR		1N21HM	1N21HMR		5.0
S			1N416H	1N416HM	1N416HMR		5.0
C	1N150	1N150R		1N150M	1N150MR	2.0	9.8
C	1N160	1N160R		1N160M	1N160MR	2.7	11.4



ELECTRICAL CHARACTERISTICS →				TEST CONDITIONS			PACKAGE OUTLINE	
BURNOUT ERGS	Z _{IF} ² OHMS		VSWR MAX	CONVERSION LOSS MAX, dB	FREQUENCY MHz	LO POWER mW		BASIC TYPE
	MIN	MAX						
6.5 ¹	100	400		8.0	1000	1.25	1N25	DO-22
6.5 ¹	100	300		6.5	1000	1.25	1N25A	DO-22
6.5 ¹	100	300		5.5	1000	1.25	1N25B	DO-22
2.0	300	500		5.5	3060	0.5	1N21C	DO-22
				5.5	3060	0.5	1N4294	DO-22
2.0	300	500		5.5	3060	0.5	1N416C	DO-23
2.0	300	500	—	5.5	3060	0.5	1N831	DO-7
10.0	300	500	—	5.5	3060	0.5	1N3655	DO-23
2.0	325	475	1.5	5.0	3060	0.5	1N21D	DO-22
2.0	325	475	1.5	5.0	3060	0.5	1N416D	DO-23
5.0	350	450	1.3	—	3060	0.5	1N21E	DO-22
5.0	350	450	1.3	—	3060	0.5	1N416E	DO-23
5.0	350	450	1.3	—	3060	0.5	1N21WE	DO-23
	300	500	—	—	3060	0.5	1N831	DO-7
10.0	350	450	1.3	5.5	3060	0.5	1N3655A	DO-23
5.0	350	450	1.3	—	3060	0.5	1N21F	DO-22
5.0	350	450	1.3	—	3060	0.5	1N416F	DO-23
10.0	350	450	1.3	5.5	3060	0.5	1N3655B	DO-23
5.0	300	500	—	—	3060	0.5	1N831B	DO-7
5.0	300	500	—	—	3060	0.5	1N831C	DO-7
5.0	350	450	1.3	—	3060	0.5	1N21G	DO-22
5.0	350	450	1.3	—	3060	0.5	1N416G	DO-23
5.0	350	450	1.3	—	3060	0.5	1N21WG	DO-23
5.0	350	450	1.3	—	3060	0.5	1N21H	DO-22
5.0	350	450	1.3	—	3060	0.5	1N416H	DO-23
1.0	200	500	1.5	6.0	6750	1.0	1N150	DO-22
1.0	200	500		6.5	6750	1.0	1N160	DO-22

POINT CONTACT MIXER DIODES

X-BAND

FREQUENCY BAND	TYPE NUMBER					NOISE	
	POLARITY			MATCHED PAIRS		NOISE RATIO MAX.	NOISE ¹ FIGURE N_f , dB MAX.
	FORWARD	REVERSE	REVERSIBLE	TWO FORWARD POLARITY DIODES	ONE FORWARD ONE REVERSE POLARITY DIODES		
X	1N23C	1N23CR		1N23CM	1N23CMR	2.0	9.5
X			1N415C	1N415CM	1N415CMR	2.0	9.5
X			1N832	1N832M		2.0	9.5
X	1N2510	1N2510R		1N2510M	1N2510MR	2.0	9.5
X			1N3745	1N3745M	1N3745MR	—	9.5
X			1N3746	1N3746M	1N3746MR	—	8.5
X	1N149	1N149R		1N149M	1N149MR	1.5	8.3
X	1N23D	1N23DR		1N23DM	1N23DMR	1.7	7.8
X			1N415D	1N415DM	1N416DMR	1.7	7.8
X	1N23E	1N23ER		1N23EM	1N23EMR	—	7.5
X			1N23WE	1N23WEM	1N23WEMR	—	7.5
X			1N415E	1N415EM	1N415EMR	—	7.5
X			1N832A	1N832AM		—	7.5
X			1N3747W	1N3747WM	1N3747WMR	—	7.5
X	1N23F	1N23FR		1N23FM	1N23FMR	—	7.0
X			1N23WF	1N23WFM	1N23WFMR	—	7.0
X			1N415F	1N415FM	1N416FMR	—	7.0
X			1N832B	1N832BM		—	7.0
X	1N23G	1N23GR		1N23GM	1N23GMR	—	6.5
X			1N23WG	1N23WGM	1N23WGMR	—	6.5
X			1N451G	1N415GM	1N415GMR	—	6.5
X			1N832C	1N832CM		—	6.5
X	1N23H	1N23HR		1N23HM	1N23HMR	—	6.0
X			1N415H	1N451HM	1N415HMR	—	6.0

ELECTRICAL CHARACTERISTICS →				TEST CONDITIONS			PACKAGE OUTLINE	
BURNOUT ERGS	Z _{if} ² OHMS		VSWR MAX	CONVERSION LOSS MAX, dB	FREQUENCY MHz	LO POWER mW		BASIC TYPE
	MIN	MAX						
2.0	325	475	1.5	6.0	9375	1.0	1N23C	DO-22
2.0	325	475	1.5	6.0	9375	1.0	1N415C	DO-23
2.0	250	550	—	6.0	9375	1.0	1N832	DO-7
2.0	300	500	—	6.0	9375	1.0	1N2510	DO-37
2.0	325	475	1.5	—	9375	1.0	1N3745	DO-23
5.0	335	465	1.3	—	9375	1.0	1N3746	DO-23
2.0	325	475	—	5.5	9375	1.0	1N149	DO-22
2.0	350	450	1.3	5.0	9375	1.0	1N23D	DO-22
2.0	350	450	1.3	5.0	9375	1.0	1N415D	DO-23
2.0	335	465	1.3	—	9375	1.0	1N23E	DO-22
2.0	335	465	1.3	—	9375	1.0	1N23WE	DO-23
2.0	335	465	1.3	—	9375	1.0	1N415E	DO-23
2.0	250	550	—	—	9375	1.0	1N832A	DO-7
5.0	335	465	1.3	—	9375	1.0	1N3747W	DO-23
2.0	335	465	1.3	—	9375	1.0	1N23F	DO-22
2.0	335	465	1.3	—	9375	1.0	1N23WF	DO-23
2.0	335	465	1.3	—	9375	1.0	1N415F	DO-23
2.0	250	550	—	—	9375	1.0	1N832B	DO-7
2.0	335	465	1.3	—	9375	1.0	1N23G	DO-22
2.0	335	465	1.3	—	9375	1.0	1N23WG	DO-23
2.0	335	465	1.3	—	9375	1.0	1N415G	DO-23
2.0	250	550	—	—	9375	1.0	1N832C	DO-7
2.0	335	465	1.3	—	9375	1.0	1N23H	DO-22
2.0	335	465	1.3	—	9375	1.0	1N415H	DO-23

POINT CONTACT MIXER DIODES

Kμ, K-BAND

FREQUENCY BAND	TYPE NUMBER					NOISE	
	POLARITY			MATCHED PAIRS		NOISE RATIO MAX.	NOISE ¹ FIGURE N _p dB MAX.
	FORWARD	REVERSE	REVERSIBLE	TWO FORWARD POLARITY DIODES	ONE FORWARD ONE REVERSE POLARITY DIODES		
Kμ	1N78	1N78R		1N78M	1N78MR	2.5	—
Kμ	1N78A	1N78AR		1N78AM	1N78AMR	1.5	—
Kμ	1N78B	1N78BR		1N78BM	1N78BMR	1.3	10.0
Kμ	1N3205	1N3205R		1N3205M	1N3205MR	1.4	9.8
Kμ	1N78C	1N78CR		1N78CM	1N78CMR	—	9.5
Kμ	1N4603 ³	1N4603R ³		1N4603M	1N4603MR	—	9.5
Kμ	1N78D	1N78DR		1N78DM	1N78DMR	—	8.8
Kμ	1N4604 ³	1N4604R ³		1N4604M	1N4604MR	—	8.8
Kμ	1N78E	1N78ER		1N78EM	1N78EMR	—	8.0
Kμ	1N4605 ³	1N4605R ³		1N4605M	1N4605MR	—	8.0
Kμ	1N78F	1N78FR		1N78FM	1N78FMR	—	7.5
Kμ	1N78G	1N78GR		1N78GM	1N78GMR	—	7.0
K	1N26	1N26R		1N26M	1N26MR	2.5	13.1
K	1N26A	1N26AR		1N26AM	1N26AMR	2.0	11.3
K	1N26B	1N26BR		1N26BM	1N26BMR	1.5	11.0
K	1N26C	1N26CR		1N26CM	1N26CMR	1.5	9.5

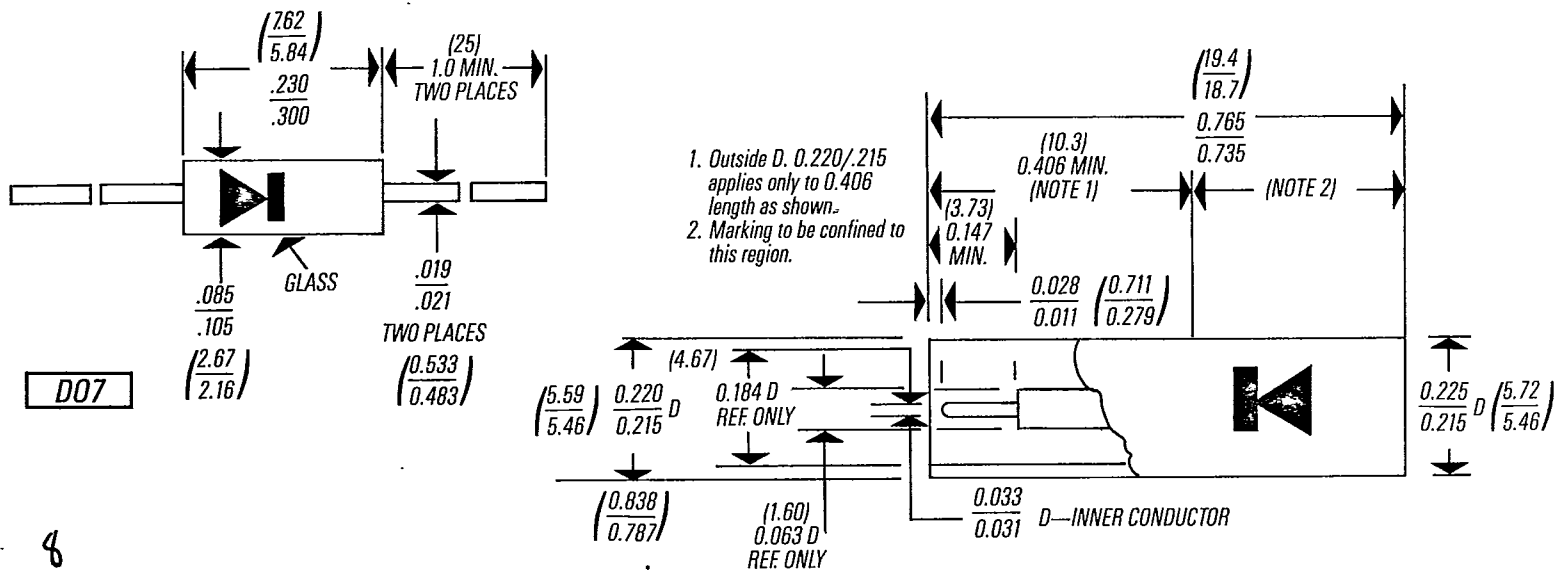

D07

D037



ELECTRICAL CHARACTERISTICS →				TEST CONDITIONS			PACKAGE OUTLINE	
BURNOUT ERGS	Z_{in}^2 OHMS		VSWR MAX	CONVERSION LOSS MAX, dB	FREQUENCY MHz	LO POWER mW		BASIC TYPE
	MIN	MAX						
1.0	325	625	—	7.5	16000	1.0	1N78	DO-37
1.0	365	565	1.6	7.0	16000	1.0	1N78A	DO-37
1.0	365	565	1.6	6.5	16000	1.0	1N78B	DO-37
1.0	365	565	1.6	6.3	16000	1.0	1N3205	DO-37
1.0	400	565	1.5	6.0	16000	1.0	1N78C	DO-37
1.0	365	565	1.5	—	16000	1.0	1N4603	DO-37
1.0	400	565	1.5	5.7	16000	1.0	1N78D	DO-37
1.0	400	565	1.5	—	16000	1.0	1N4604	DO-37
1.0	400	565	1.5	5.7	16000	1.0	1N78E	DO-37
1.0	400	565	1.5	—	16000	1.0	1N4605	DO-37
1.0	400	565	1.5	5.7	16000	1.0	1N78F	DO-37
1.0	400	565	1.5	—	16000	1.0	1N78G	DO-37
0.3	300	600	—	8.5	23984	1.0	1N26	DO-37
0.3	300	600	1.6	7.5	23984	1.0	1N26A	DO-37
0.3	400	600	1.5	7.5	23984	1.0	1N26B	DO-37
0.3	400	600	1.5	7.5	23984	1.0	1N26C	DO-37

N O T E S

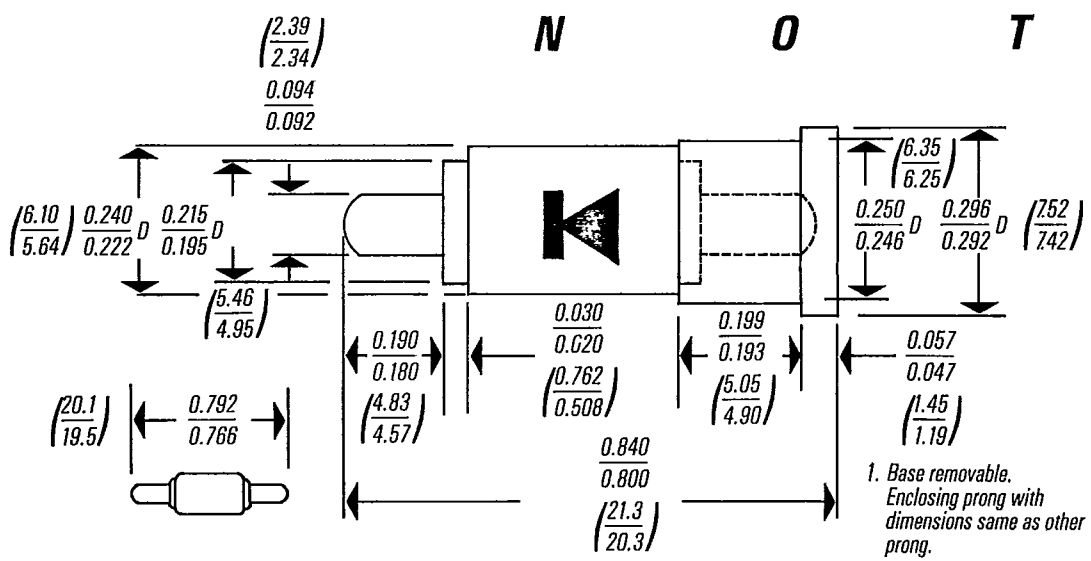

1. Test Conditions: $NF_{IF} = 1.5\text{dB}$, $f_c = 30\text{ MHz}$, $R_L = 100\text{ Ohms}$.
2. If impedance is measured by modulating the specified test frequency with a 1000Hz signal, $R_L = 22\text{ Ohms}$, at the specified incident power level.
3. Broadband Device.

1. Base removable. Enclosing prong with dimensions same as other prong.

9

D023 Removable Base

D022 Fixed Base